

- CV** Check Valves
- SH** Shuttle Valves
- LM** Load/Motor Controls
- FC** Flow Controls
- PC** Pressure Controls
- LE** Logic Elements
- DC** Directional Controls
- MV** Manual Valves
- SV** Solenoid Valves
- PV** Proportional Valves
- CE** Coils & Electronics
- BC** Bodies & Cavities
- TD** Technical Data

General Description

Poppet Type Needle Valve with Reverse Flow Check. For additional information see Technical Tips on pages FC1-FC4.

Features

- Shuts off to a very low leakage level
- Good adjustment sensitivity - ideal for fine control
- Good contamination tolerant
- Adjustable and tamperproof versions available
- All external parts zinc plated

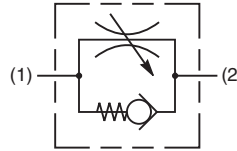
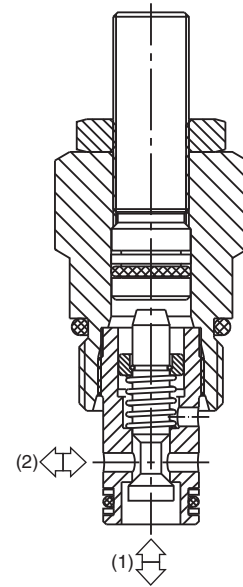
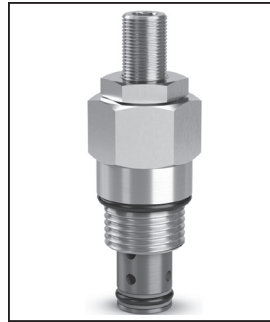

Specifications

Rated Flow	30 LPM (8 GPM)
Maximum Inlet Pressure	420 Bar (6000 PSI)
Cartridge Material	All parts steel. All operating parts hardened steel.
Operating Temp. Range/Seals	-34°C to +121°C (Nitrile) (-30°F to +250°F) -26°C to +204°C (Fluorocarbon) (-15°F to +400°F)
Fluid Compatibility/Viscosity	Mineral-based or synthetic with lubricating properties at viscosities of 45 to 2000 SSU (6 to 420 cSt)
Filtration	ISO-4406 18/16/13, SAE Class 4
Approx. Weight	.11 kg (.24 lbs.)
Cavity	C08-2 (See BC Section for more details)
Form Tool	Rougher Finisher None None NTF08-2F

Performance Curves (Through cartridge only)

Low Pressure Drop vs. Flow 1 to 2 & 2 to 1

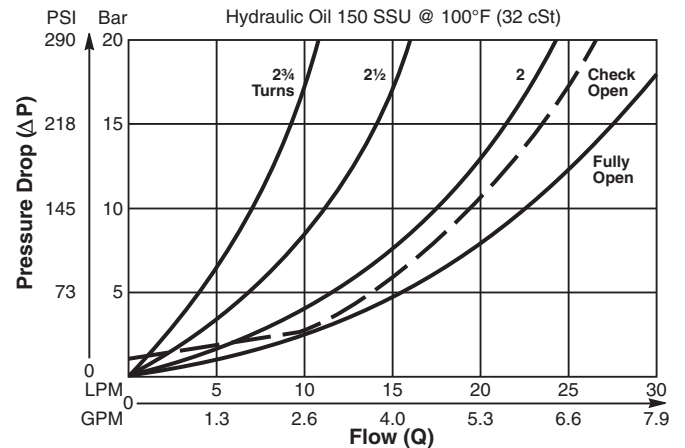

High Pressure Drop vs. Flow 1 to 2

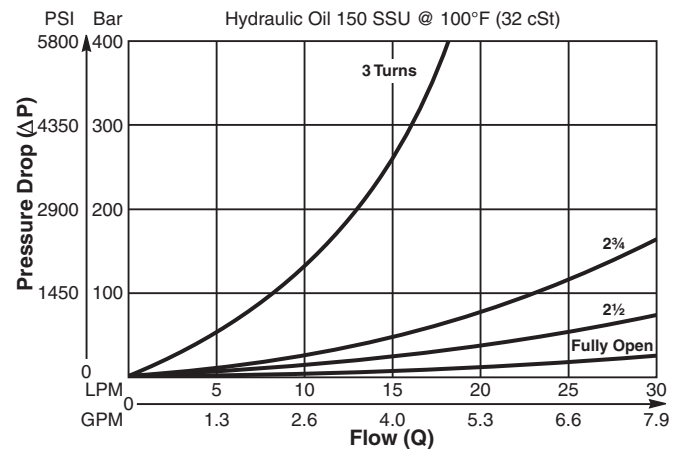

Dimensions Millimeters (Inches)

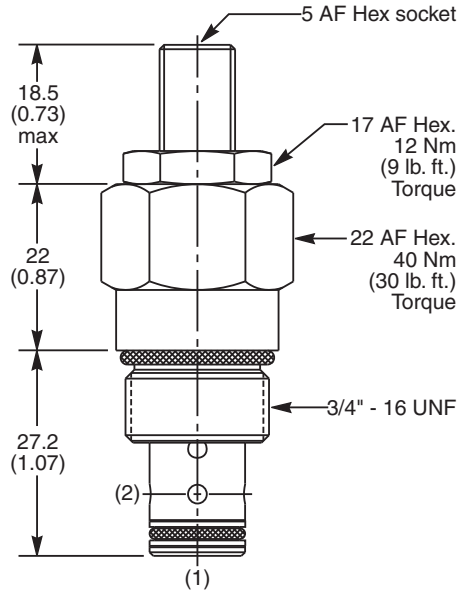

Ordering Information

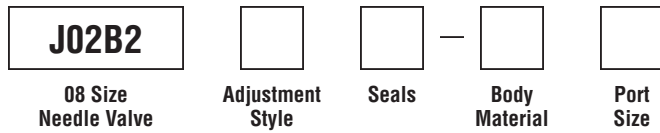

Code	Adjustment Style
Z	Screw Adjust (Std.)
W	Knob Adjust
T	Tamper Resistant Cap (TC1130)

Code	Seals / Kit. No.
N	Nitrile, Buna-N (Std.) / (SK30500N-1)
V	Fluorocarbon / (SK30500V-1)

Code	Body Material
Omit	Steel
A	Aluminum

Code	Port Size	Body Part No.
Omit	Cartridge Only	
4T	SAE-4	(B08-2-*4T)
6T	SAE-6	(B08-2-*6T)

* Add "A" for aluminum, omit for steel.

- CV
Check Valves
- SH
Shuttle Valves
- LM
Load/Motor Controls
- FC
Flow Controls
- PC
Pressure Controls
- LE
Logic Elements
- DC
Directional Controls
- MV
Manual Valves
- SV
Solenoid Valves
- PV
Proportional Valves
- CE
Coils & Electronics
- BC
Bodies & Cavities
- TD
Technical Data